



1 Quai du Président Wilson,
33130 Bordeaux, Francia
Tel. +33 5 56 20 59 89
commercial.france@vidrala.com

BUCKET 275 ML

Características do produto

| | |
|---------------------|----------------|
| Código | 2225/085 |
| Capacidade | 275 ml |
| Boca | TWIST OFF 58 |
| Cores | |
| Peso | 170 gr |
| Altura Total | 123.00 mm |
| Diâmetro | 68.00 mm |
| Paquete | 4.624 Unidades |

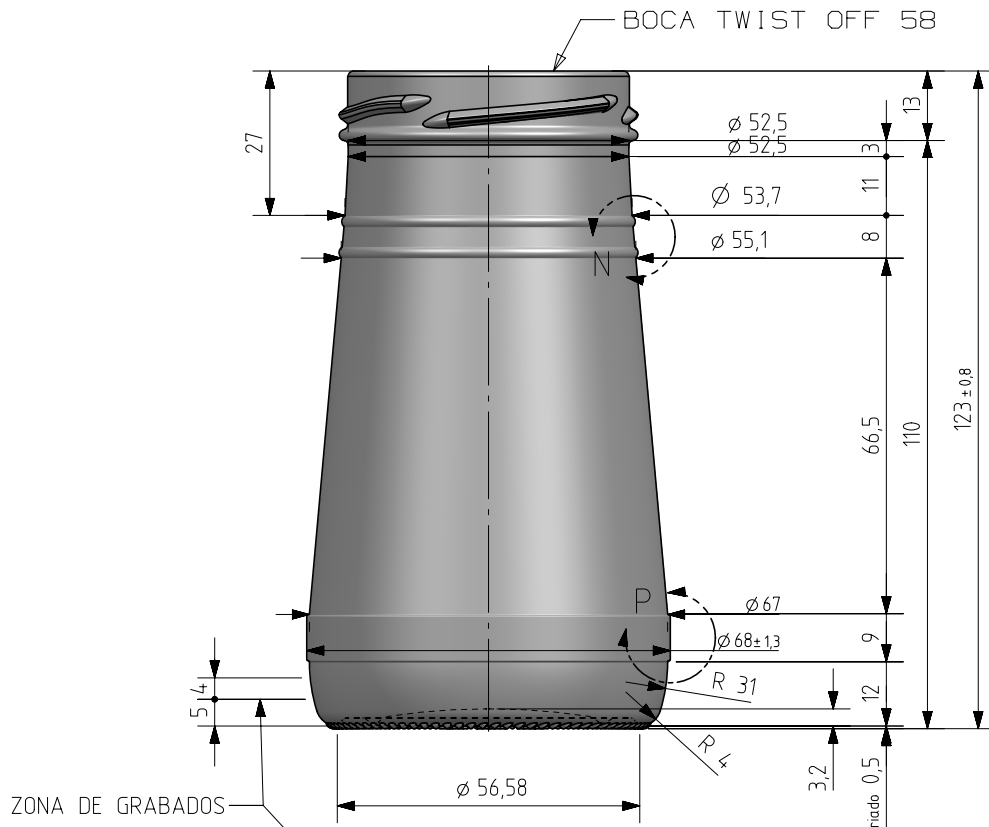

DETALLE N
ESCALA 3:1

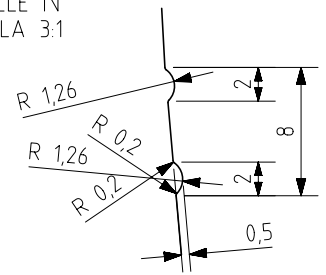

DETALLE P
ESCALA 3:1

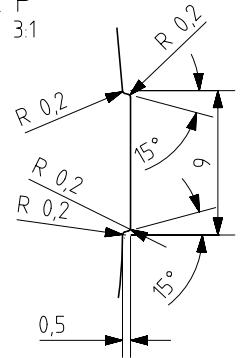

ZONA DE GRABADOS

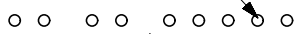

N° MOLDE
ANAGRAMA
AÑO FABRICACIÓN
N° MODELO

VISTA DEL FONDO

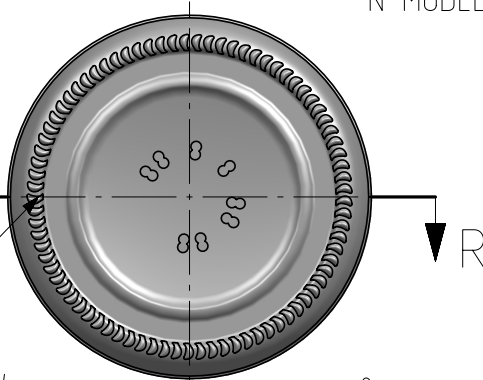

ESTRIADO UÑAS

SECTION R-R

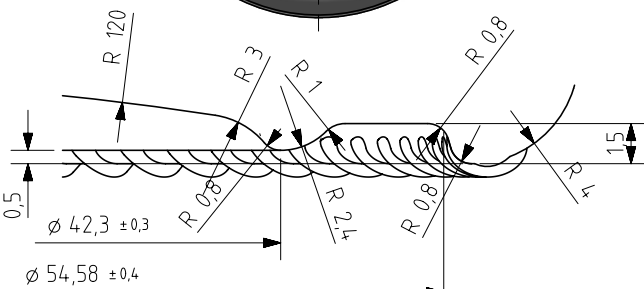

Este plano es propiedad de Vidrala, no puede ser reproducido ni comunicado sin nuestro permiso. Las cotas no toleradas son aproximadas.

Specification agreements are based on tolerances dimensions only. Do not scale drawing copyright. Not to be copied in whole or part without written permission from VIDRALA. All dimensions are in millimeters.

| 1 | Renombrada boca 521 como 085 | 29-11-17 | JAU |
|--|------------------------------|------------|-------------------|
| Rev | Modificación / Modification | Fecha/Date | Firma/Sign |
| Peso aprox / Weight approx | | 170 | gr |
| Capacidad N. llenado / Fillpoint Capacity | | 275 | cc± 6 a ,0 mm |
| Capacidad a verter / Brimfull Capacity | | 275,0 | cc± 6 |
| Cámara expansión / Vacuity | | ,0 | % 0 cc |
| Recipiente medida / Meas cap | | NO | |
| Angulo de volcado / Tilt angle | | 33,5 ° | |
| Carbonatación / Gas vol | | 0,0 | Vol.CO2 máx |
| Presión larga duración/Long term pressure: | | 0,00 | Bar Max Páster SI |
| Resistencia: choque térmico / Thermal Shock Max: | | 42 °C | |

| | | | |
|--|--|---|--|
|  | | Product Design Office www.vidrala.com | |
| Dibujado / Des : J. Ochoa | | CAD: 7205-1prt | |
| Fecha / Date: 05-12-13 | | Anula / Annuls: 7205 | |
| Escala / Escala: 1:1 | | N° Plano: 7205-1 | |
| Retornable / Refillable: NO | | Drawing N°: 62,1% | |
| Modelo: 2225/085 | | BUCKET 275 ml | |