



1 Quai du Président Wilson,  
33130 Bordeaux, Francia  
Tel. +33 5 56 20 59 89  
commercial.france@vidrala.com

# BUCKET 275 ML

## Product characteristics

<b>Code</b>	2225/085
<b>Capacity</b>	275 ml
<b>Colours</b>	<input type="checkbox"/>
<b>Weight</b>	170 gr
<b>Overall height</b>	123.00 mm
<b>Diameter</b>	68.00 mm
<b>Palet</b>	4.624 units

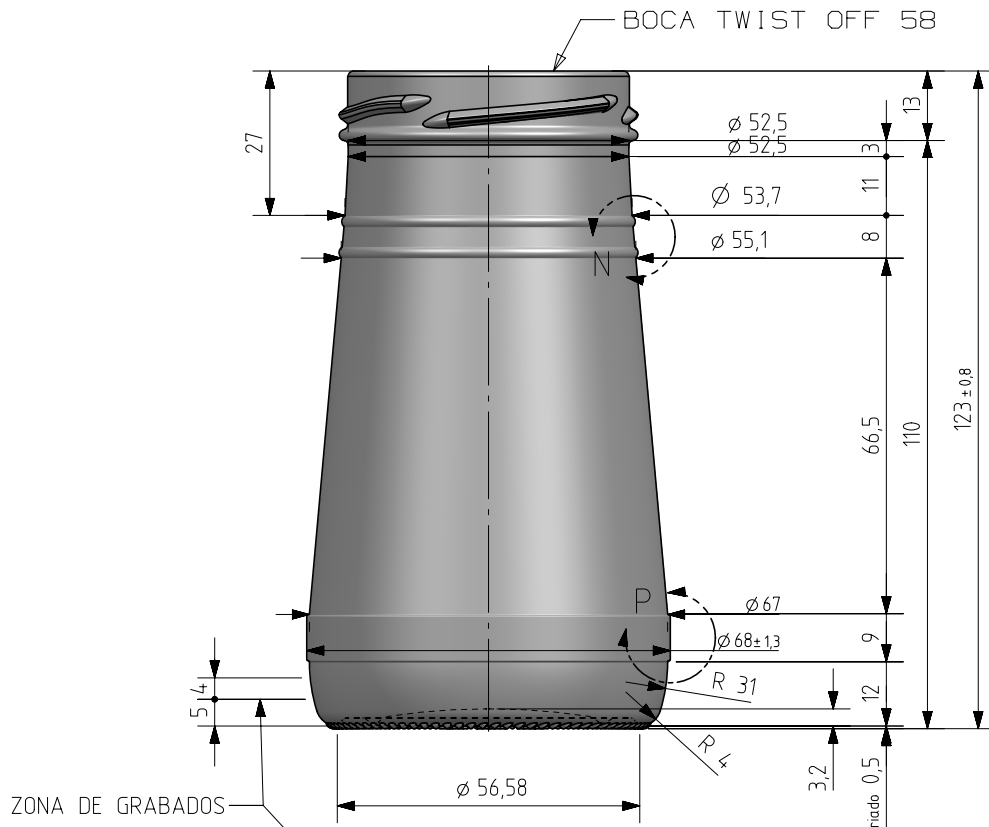

DETALLE N  
ESCALA 3:1

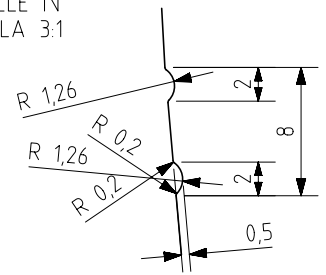

DETALLE P  
ESCALA 3:1

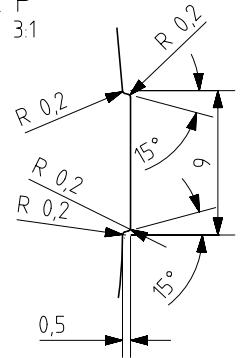

ZONA DE GRABADOS

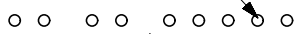

N° MOLDE  
ANAGRAMA  
AÑO FABRICACIÓN  
N° MODELO

VISTA DEL FONDO

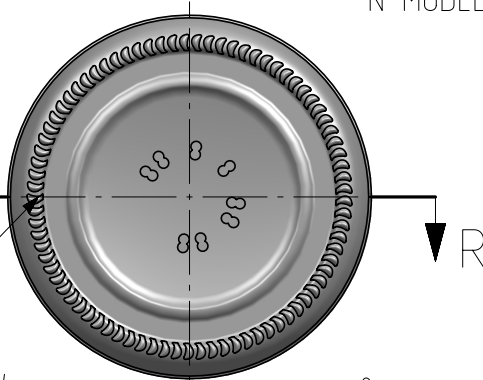

ESTRIADO UÑAS

SECTION R-R

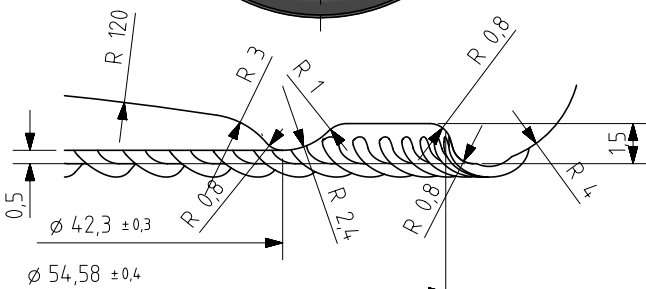

Este plano es propiedad de Vidrala, no puede ser reproducido ni comunicado sin nuestro permiso.

Las cotas no toleradas son aproximadas.

Specification agreements are based on tolerances dimensions only. Do not make drawing copyright.

Not to be copied in whole or part without written permission from VIDRALA

All dimensions are in millimeters

1	Renombrada boca 521 como 085	29-11-17	JAU
Rev	Modificación / Modification	Fecha/Date	Firma/Sign
Peso aprox / Weight approx		170	gr
Capacidad N. llenado / Fillpoint Capacity		275	cc± 6 a ,0 mm
Capacidad a verter / Brimfull Capacity		275,0	cc± 6
Cámara expansión / Vacuity		,0	% 0 cc
Recipiente medida / Meas cap		NO	
Angulo de volcado / Tilt angle		33,5 °	
Carbonatación / Gas vol		0,0	Vol.CO2 máx
Presión larga duración/Long term pressure:		0,00	Bar Max Páster SI
Resistencia: choque térmico / Thermal Shock Max:		42 °C	

		Product Design Office www.vidrala.com	
Dibujado / Des : J. Ochoa		CAD: 7205-1prt	
Fecha / Date: 05-12-13		Anula / Annuls: 7205	
Escala / Escala: 1:1		N° Plano: 7205-1	
Retornable / Refillable: NO		Drawing N°: 62,1%	
Modelo: 2225/085		BUCKET 275 ml	