

BG 37,5 CL

Características do produto

Código	1005/242
Capacidade	375 ml
Boca	CORCHO CETIE
Cores	
Peso	300 gr
Altura Total	240.50 mm
Diâmetro	64.10 mm
Palete	2.576 Unidades

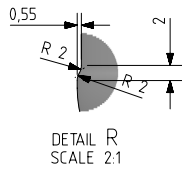

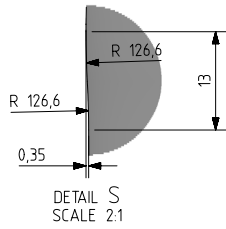
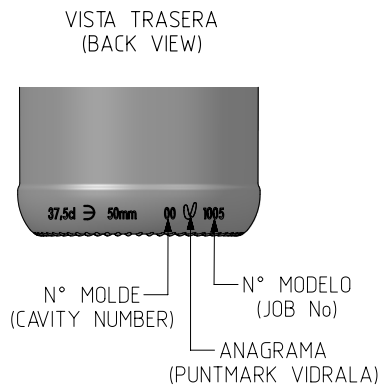



ZONA DE GRABADOS / HEEL EMBOSING
(Opuesto al código de ptos / Opposite to dot code)

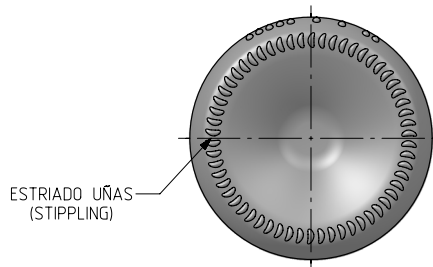
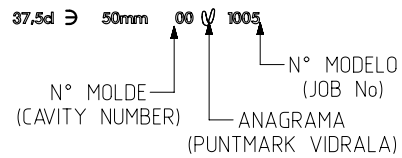
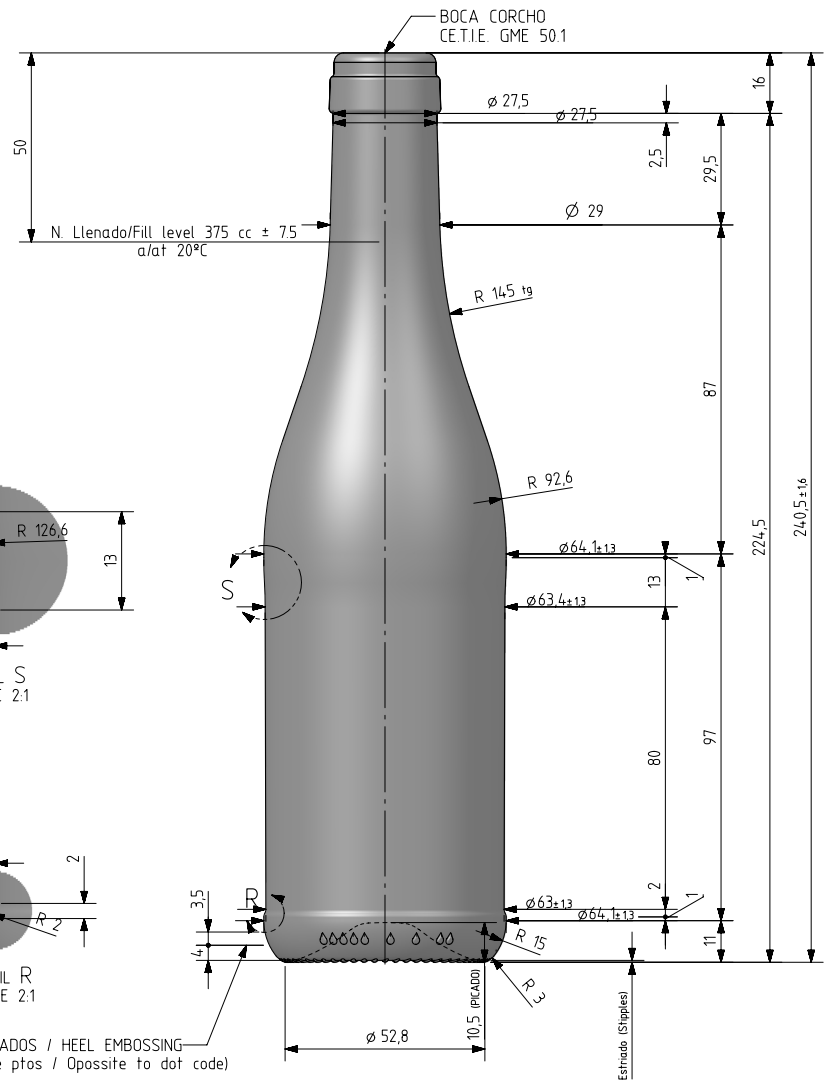

VISTA FRONTAL (FRONT VIEW)



VISTA DEL FONDO (BOTTOM VIEW)

			Peso aprox / Weight approx	300 gr	 Product Design Office www.vidrala.com	
			Capacidad N. llenado / Fillpoint Capacity	375 cc \pm 75 a 50 mm		
			Capacidad a verter / Brimfull Capacity	390 cc \pm aprox	Dibujado / Des. ALR. CAD: 7974-10.prt	
10	Eliminada letra de año y pasado a UGS	04-04-19	JAU	Cámara expansión / Vacuity	4,0 % 15 cc	
9	Se mod superior etiqueta, z.e. de 72mm a 80mm, cuerpo de ϕ 64,8 a ϕ 64,1	23-07-04	ALR.	Recipiente medida / Meas cap	SI	
8	Se suaviza superior etiqueta, z.e. de de 78mm a 72mm	20-07-04	ALR.	Angulo de volcado / Tilt angle	17,0°	
Rev	Modificación / Modification	Fecha/Date	Firma/Sign	Carbonatación / Gas vol	0,0 Vol CO2 máx	
Este plano es propiedad de Vidrala, no puede ser reproducido ni comunicado sin nuestro permiso. Las cotas no toleradas son aproximadas. Specification agreements are based on tolerated dimensions only. Do not scale drawing, copyright reserved. Not to be copied in whole or part without written permission from vidrala. All dimensions are in millimeters.				Presión larga duración / Long Term pressure: 0 Bar Max	Páster: NO	Modelo: 1005/242
				Resistencia. choque térmico / Thermal Shock Max:	42 °C	BORGOÑESA 37,5 cl. ESPECIAL