

BG 37,5 CL

Caractéristiques du produit

Code	1005/242
Capacité	375 ml
Bague	CORCHO CETIE
Couleurs	
Poids	300 gr
Hauteur totale	240.50 mm
Diamètre	64.10 mm
Palette	2.576 Unités

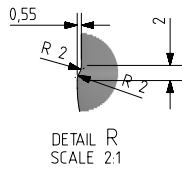

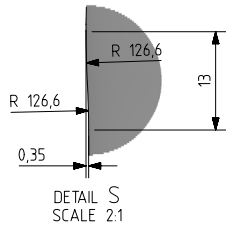
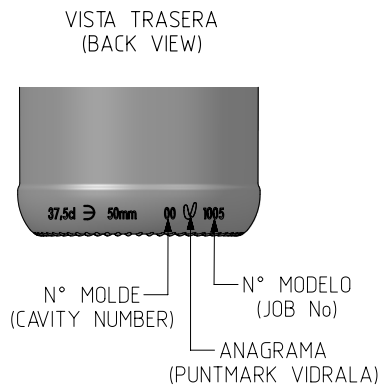



ZONA DE GRABADOS / HEEL EMBOSING
(Opuesto al código de ptos / Opposite to dot code)

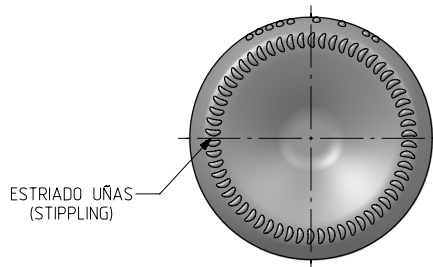
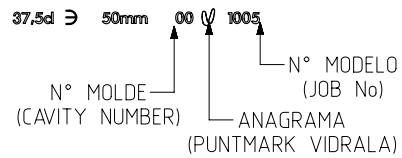
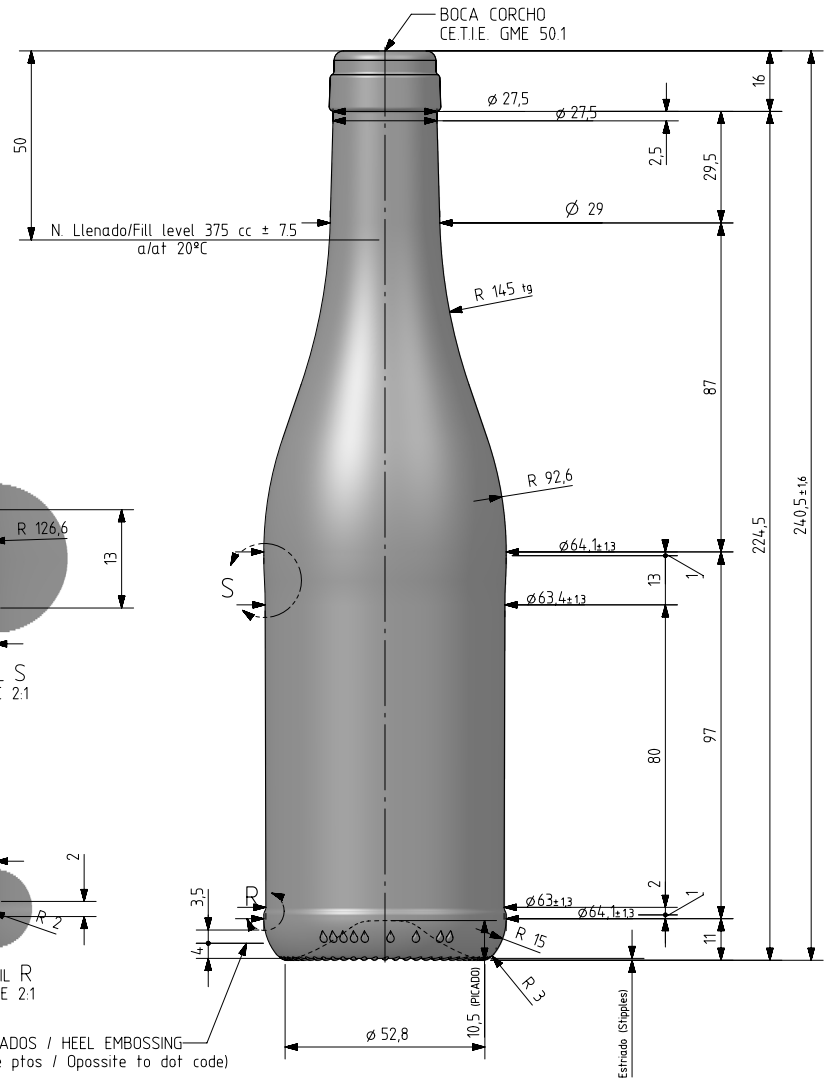

VISTA FRONTAL (FRONT VIEW)



VISTA DEL FONDO (BOTTOM VIEW)

			Peso aprox / Weight approx	300 gr	 <p>Product Design Office www.vidrala.com</p>
			Capacidad N. llenado / Fillpoint Capacity	375 cc \pm 75 a 50 mm	
			Capacidad a verter / Brimfull Capacity	390 cc \pm aprox	Dibujado / Des. ALR. CAD: 7974-10.prt
10	Eliminada letra de año y pasado a UGS	04-04-19	JAU		Fecha / Date: 04-04-19 Anula / Annuls: 7974-9
9	Se mod superior etiqueta, z.e. de 72mm a 80mm, cuerpo de ϕ 64,8 a ϕ 64,1	23-07-04	ALR.		Escala / Scale: 1:1 N° Plano: 7974-10
8	Se suaviza superior etiqueta, z.e. de de 78mm a 72mm	20-07-04	ALR.		Retornable / Returnable NO N° Plano: 60,6%
Rev	Modificación / Modification	Fecha/Date	Firma/Sign	Carbonatación / Gas vol	0,0 Vol CO2 máx
Este plano es propiedad de Vidrala, no puede ser reproducido ni comunicado sin nuestro permiso. Las cotas no toleradas son aproximadas. Specification agreements are based on tolerated dimensions only. Do not scale drawing, copyright reserved. Not to be copied in whole or part without written permission from vidrala. All dimensions are in millimeters.				Presión larga duración / Long Term pressure: 0 Bar Max	Páster: NO
				Resistencia. choque térmico / Thermal Shock Max:	42 °C
				Modelo: 1005/242	BORGOÑESA 37,5 cl. ESPECIAL