

# BUCKET 275 ML

## Caractéristiques du produit

<b>Code</b>	2225/085
<b>Capacité</b>	275 ml
<b>Bague</b>	TWIST OFF 58
<b>Couleurs</b>	
<b>Poids</b>	170 gr
<b>Hauteur totale</b>	123.00 mm
<b>Diamètre</b>	68.00 mm
<b>Palette</b>	4.624 Unités

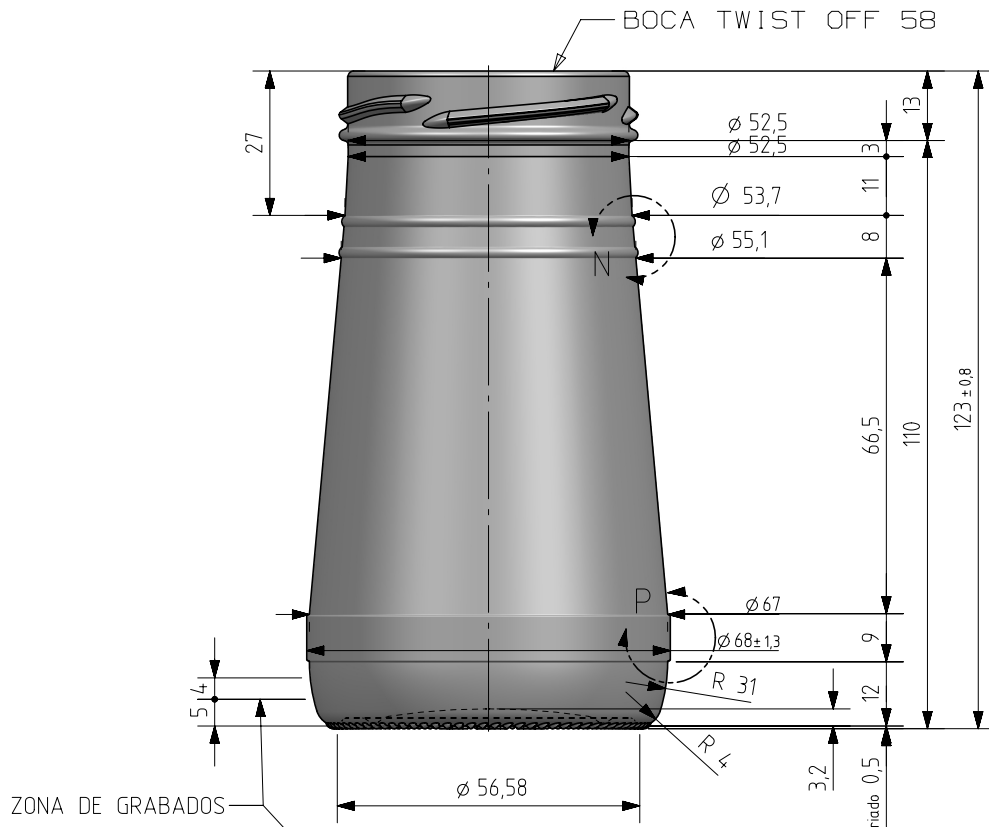



DETALLE N  
ESCALA 3:1

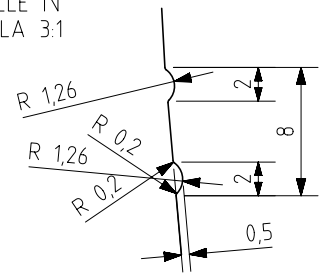

DETALLE P  
ESCALA 3:1

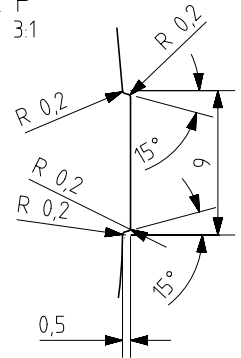

ZONA DE GRABADOS

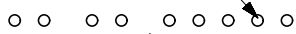

N° MOLDE  
ANAGRAMA  
AÑO FABRICACIÓN  
N° MODELO

VISTA DEL FONDO

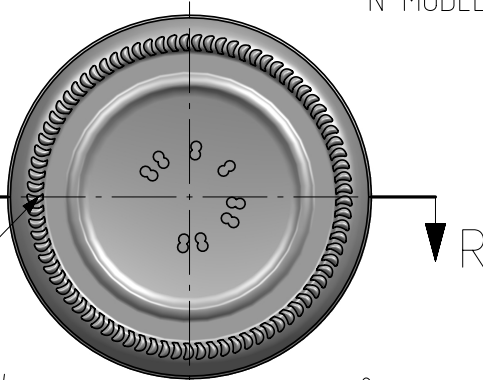

ESTRIADO UÑAS

SECTION R-R

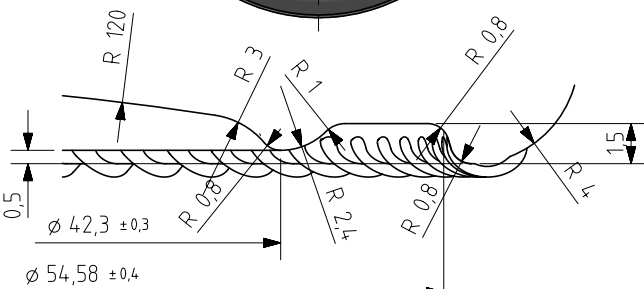

Este plano es propiedad de Vidrala, no puede ser reproducido ni comunicado sin nuestro permiso.

Las cotas no toleradas son aproximadas.

Specification agreements are based on tolerances dimensions only. Do not make drawing copyright.

Not to be copied in whole or part without written permission from VIDRALA

All dimensions are in millimeters

1	Renombrada boca 521 como 085	29-11-17	JAU				
Rev	Modificación / Modification	Fecha/Date	Firma/Sign	Rev	Modificación / Modification	Fecha/Date	Firma/Sign
Peso aprox / Weight approx		170	gr				
Capacidad N. llenado / Fillpoint Capacity		275	cc± 6 a ,0 mm				
Capacidad a verter / Brimfull Capacity		275,0	cc± 6				
Cámara expansión / Vacuity		,0	%	0	cc		
Recipiente medida / Meas cap		NO					
Angulo de volcado / Tilt angle		33,5 °					
Carbonatación / Gas vol		0,0		Vol.CO2 máx			
Presión larga duración/Long term pressure:		0,00	Bar Max	Páster		SI	
Resistencia: choque térmico / Thermal Shock Max:		42		°C			
				Modelo: Code: 2225/085		Product Design Office www.vidrala.com	
				Dibujado / Des : J. Ochoa		CAD: 7205-1prt	
				Fecha / Date: 05-12-13		Anula / Annuls: 7205	
				Escala / Escala: 1:1		N° Plano: Drawing N°: 7205-1	
				Retornable / Refillable NO		62,1%	
						BUCKET 275 ml	