

BUCKET 275 ML

Product characteristics

Code	2225/085
Capacity	275 ml
Colours	
Weight	170 gr
Overall height	123.00 mm
Diameter	68.00 mm
Palet	4.624 units

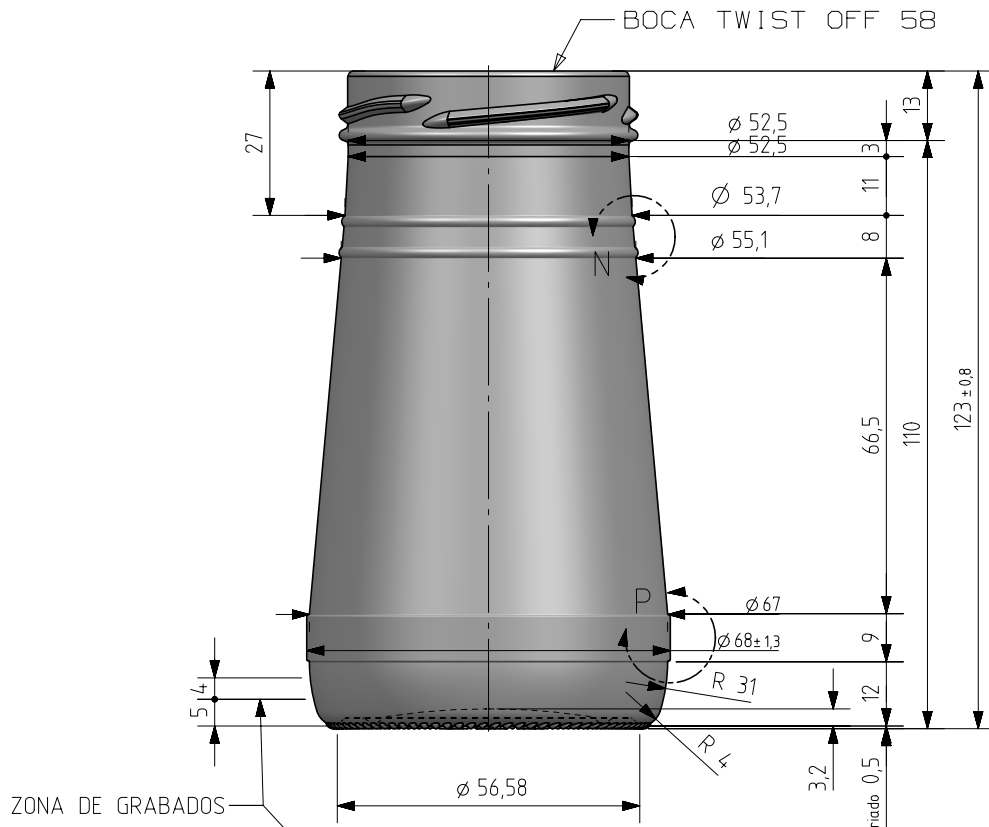



DETALLE N
ESCALA 3:1

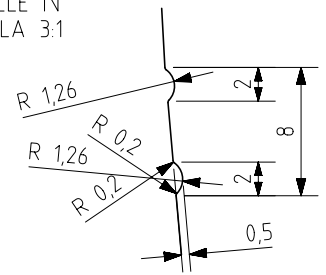

DETALLE P
ESCALA 3:1

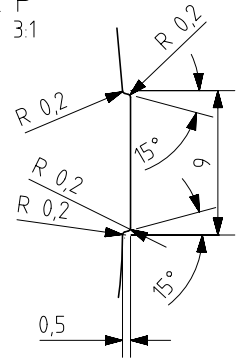

ZONA DE GRABADOS

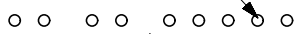

N° MOLDE
ANAGRAMA
AÑO FABRICACIÓN
N° MODELO

VISTA DEL FONDO

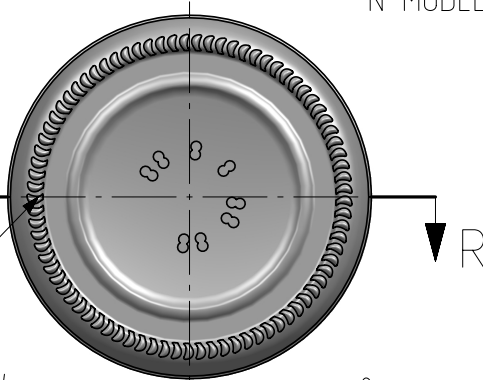

ESTRIADO UÑAS

SECTION R-R

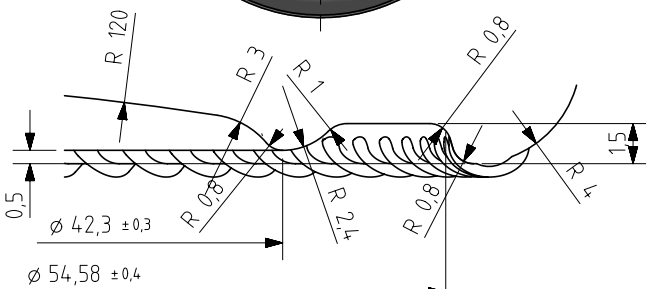

Este plano es propiedad de Vidrala, no puede ser reproducido ni comunicado sin nuestro permiso.

Las cotas no toleradas son aproximadas.

Specification agreements are based on tolerances dimensions only. Do not make drawing copyright.

Not to be copied in whole or part without written permission from VIDRALA

All dimensions are in millimeters

1	Renombrada boca 521 como 085	29-11-17	JAU				
Rev	Modificación / Modification	Fecha/Date	Firma/Sign	Rev	Modificación / Modification	Fecha/Date	Firma/Sign
Peso aprox / Weight approx		170	gr				
Capacidad N. llenado / Fillpoint Capacity		275	cc± 6	a ,0		mm	
Capacidad a verter / Brimfull Capacity		275,0	cc± 6				
Cámara expansión / Vacuity		,0	%	0	cc		
Recipiente medida / Meas cap		NO					
Angulo de volcado / Tilt angle		33,5	°				
Carbonatación / Gas vol		0,0	Vol.CO2 máx				
Presión larga duración/Long term pressure:		0,00	Bar Max	Páster		SI	
Resistencia: choque térmico / Thermal Shock Max:		42	°C				
Dibujado / Des : J. Ochoa		CAD:		7205-1prt			
Fecha / Date: 05-12-13		Anula / Annuls:		7205			
Escala / Escala: 1:1		N° Plano:		7205-1			
Retornable / Refillable: NO		Drawing N°:		62,1%			
Modelo:		Code:		2225/085		BUCKET 275 ml	



Product Design Office
www.vidrala.com